

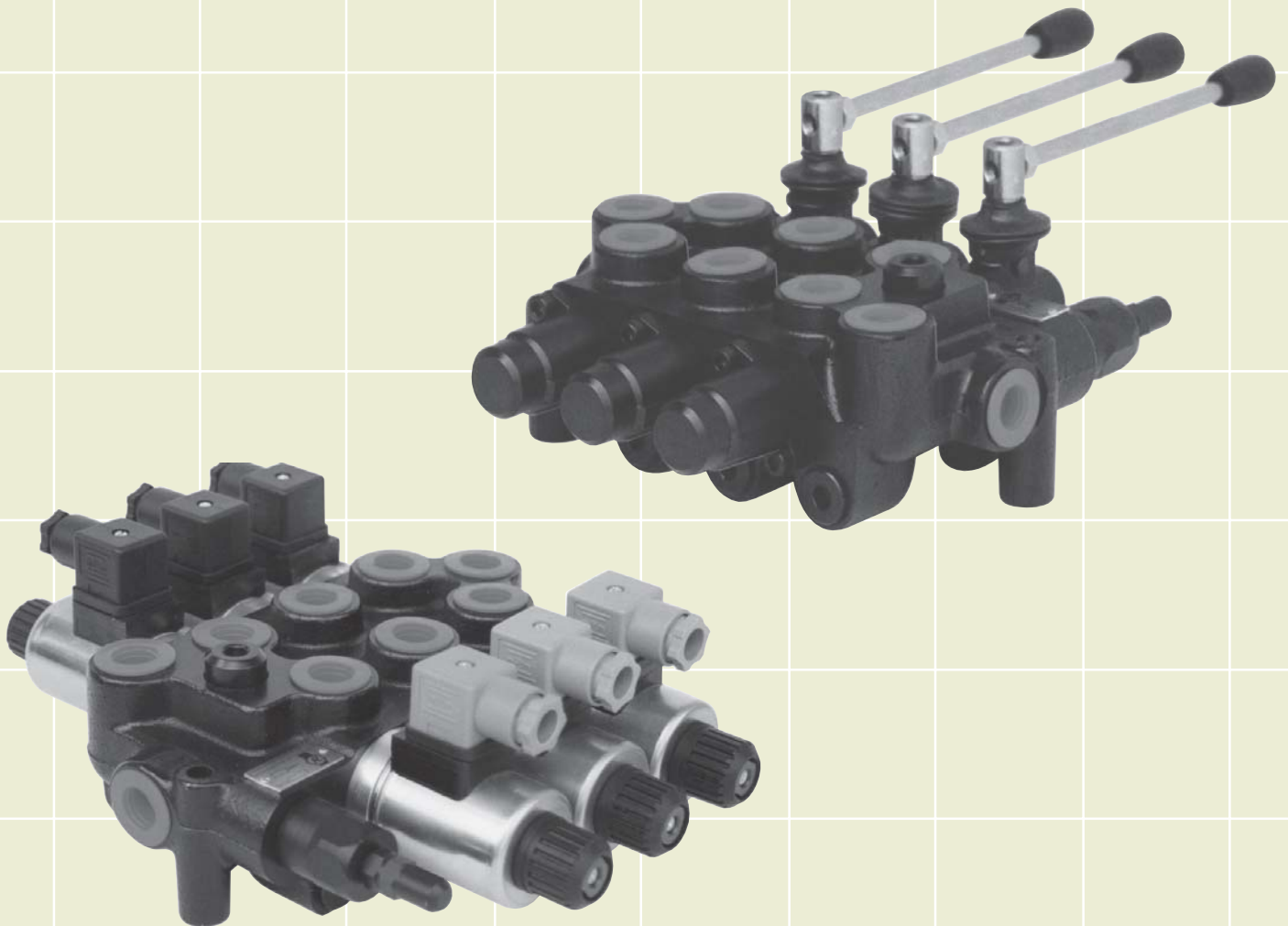

Roquet

Componentes oleo-dinámicos
Hydraulic components

08.07.00/07.02



Distribuidores manuales o eléctricos
Directional control valves
Tipo / Type 302 - 1302

Presentamos en este catálogo, nuestra gama de válvulas direccionales o distribuidores con mando eléctrico, destinados principalmente a los equipos de Obras Públicas, agricultura, pesca, etc...

Los sistemas de distribución son del tipo paralelo.

El sistema de accionamiento puede ser eléctrico o con palanca manual o la combinación de las dos.

Existe gran variedad de válvulas auxiliares (sobrepresión, aspiración,...) con la posibilidad de incorporar en cada cuerpo de distribución, para poder adecuar las prestaciones a cada necesidad de la instalación.

Las condiciones de trabajo: presión, caudal, temperatura, etc. Se especifican en el cuadro de datos técnicos

This range of parallel monoblock directional control valves is primarily intended for applications such as construction, mechanical handling and agricultural machinery etc...

The valves are actuated by hand-levers or direct-acting solenoids and can be fitted with port valves of various types.

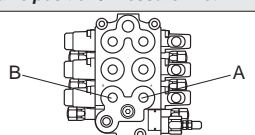
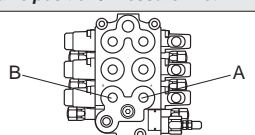
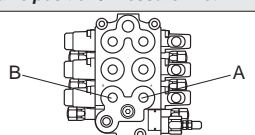
NOMENCLATURA DE REFERENCIAS	302 N 1 P2 C 12 D 24 *	CODING SYSTEMS																																																																				
<table border="1" style="width: 100%; border-collapse: collapse;"> <tr> <th style="text-align: left;">Tipo distribuidor Control valve type</th> <td>302 - 1302</td> </tr> </table>	Tipo distribuidor Control valve type	302 - 1302		<table border="1" style="width: 100%; border-collapse: collapse;"> <tr> <th style="text-align: left;">Datos adicionales Additional data</th> <td></td> </tr> <tr> <th style="text-align: left;">Gama de tensiones para C.C. (sólo para accionamiento 83-84) D.C. voltage (only for control types 83-84)</th> <td> <table border="1" style="width: 100%; border-collapse: collapse;"> <tr> <td style="width: 25%;">12</td> <td style="width: 25%;">12 V</td> <td style="width: 25%;">24</td> <td style="width: 25%;">24 V</td> </tr> </table> </td> </tr> <tr> <th style="text-align: left;">Sistemas de distribución Spool types</th> <td> <p>Ver símbolos en paginas correspondientes. NOTA: El orden de las correderas se empieza a contar a partir de la válvula de seguridad.</p> <p><i>See symbols in relevant pages. NOTE: The spool order will be listed from the pressure to the exhaust port.</i></p> </td> </tr> <tr> <th style="text-align: left;">Taraje válvula seguridad Relief valve pressure range</th> <td> <table border="1" style="width: 100%; border-collapse: collapse;"> <thead> <tr> <th style="text-align: left;">Tipo regulación / Adjustable</th> <th style="text-align: left;">Gama de taraje Pressure range bar</th> </tr> </thead> <tbody> <tr> <td>Regulable / Adjustable</td> <td></td> </tr> <tr> <td>11</td> <td>5 - 80</td> </tr> <tr> <td>12</td> <td>85 - 175</td> </tr> <tr> <td>13</td> <td>180 - 250</td> </tr> <tr> <td>14</td> <td>255 - 350</td> </tr> </tbody> </table> <p><small>Para distribuidores sin válvula de seguridad se omitirá el número de taraje. For valves without reliefs the pressure range number is omitted</small></p> </td> </tr> <tr> <th style="text-align: left;">Posición vál. de seguridad o entrada presión Relief valve position / Pressure inlet</th> <td style="text-align: center;">  </td> </tr> <tr> <th style="text-align: left;">Accionamiento corredera Spool positioning devices</th> <td> <table border="1" style="width: 100%; border-collapse: collapse;"> <tr> <td style="width: 5%;">1</td> <td style="width: 85%;">Tres posiciones recuperación por muelle. <i>Three positions, return to neutral by spring.</i></td> <td style="width: 10%; text-align: right;">5-175 bar</td> </tr> <tr> <td>2</td> <td>Tres posiciones con anclajes. <i>Three positions with detent.</i></td> <td></td> </tr> <tr> <td>5</td> <td>Microrruptor. <i>Microswitch.</i></td> <td></td> </tr> <tr> <td>9</td> <td>Dos posiciones extremas con anclajes. <i>Two ends positions with detent.</i></td> <td></td> </tr> <tr> <td>20</td> <td>Cuatro posiciones, tres normales y la cuarta anclada tirando corredera. <i>Four positions, three return by spring the fourth detented pulling spool.</i></td> <td></td> </tr> <tr> <td>37</td> <td>Accionamiento doble, dos correderas con una palanca. <i>Double action, two spools with one lever.</i></td> <td></td> </tr> <tr> <td>83</td> <td>Accionamiento por electroimán directo, tres posiciones centraje por muelle. <i>Direct solenoid operated, three positions spring centred.</i></td> <td></td> </tr> <tr> <td>84</td> <td>Accionamiento por electroimán directo, posición central y extrema. Electroimán lado toma A. <i>Direct solenoid operated, two positions (centre + one end). Solenoid side port A</i></td> <td></td> </tr> </table> </td> <td></td> </tr> <tr> <td></td> <td></td> <td> <table border="1" style="width: 100%; border-collapse: collapse;"> <tr> <th style="text-align: left;">Tipo de palanca mando Hand lever type</th> <td></td> </tr> <tr> <td>P2</td> <td>Palanca roscada doble con protección <i>Double threaded lever with bellows</i></td> </tr> <tr> <td>X</td> <td>Cuando lleve palancas diferentes ó múltiples <i>When different handles or joysticks are fitted</i></td> </tr> <tr> <td>I</td> <td>Accionamiento por cable <i>Cable operated</i></td> </tr> <tr> <td>S</td> <td>Sin palanca y tapa sin orejas <i>When no lever needed, a cover without ears will be assembled</i></td> </tr> </table> </td> </tr> </table>	Datos adicionales Additional data		Gama de tensiones para C.C. (sólo para accionamiento 83-84) D.C. voltage (only for control types 83-84)	<table border="1" style="width: 100%; border-collapse: collapse;"> <tr> <td style="width: 25%;">12</td> <td style="width: 25%;">12 V</td> <td style="width: 25%;">24</td> <td style="width: 25%;">24 V</td> </tr> </table>	12	12 V	24	24 V	Sistemas de distribución Spool types	<p>Ver símbolos en paginas correspondientes. NOTA: El orden de las correderas se empieza a contar a partir de la válvula de seguridad.</p> <p><i>See symbols in relevant pages. NOTE: The spool order will be listed from the pressure to the exhaust port.</i></p>	Taraje válvula seguridad Relief valve pressure range	<table border="1" style="width: 100%; border-collapse: collapse;"> <thead> <tr> <th style="text-align: left;">Tipo regulación / Adjustable</th> <th style="text-align: left;">Gama de taraje Pressure range bar</th> </tr> </thead> <tbody> <tr> <td>Regulable / Adjustable</td> <td></td> </tr> <tr> <td>11</td> <td>5 - 80</td> </tr> <tr> <td>12</td> <td>85 - 175</td> </tr> <tr> <td>13</td> <td>180 - 250</td> </tr> <tr> <td>14</td> <td>255 - 350</td> </tr> </tbody> </table> <p><small>Para distribuidores sin válvula de seguridad se omitirá el número de taraje. For valves without reliefs the pressure range number is omitted</small></p>	Tipo regulación / Adjustable	Gama de taraje Pressure range bar	Regulable / Adjustable		11	5 - 80	12	85 - 175	13	180 - 250	14	255 - 350	Posición vál. de seguridad o entrada presión Relief valve position / Pressure inlet		Accionamiento corredera Spool positioning devices	<table border="1" style="width: 100%; border-collapse: collapse;"> <tr> <td style="width: 5%;">1</td> <td style="width: 85%;">Tres posiciones recuperación por muelle. <i>Three positions, return to neutral by spring.</i></td> <td style="width: 10%; text-align: right;">5-175 bar</td> </tr> <tr> <td>2</td> <td>Tres posiciones con anclajes. <i>Three positions with detent.</i></td> <td></td> </tr> <tr> <td>5</td> <td>Microrruptor. <i>Microswitch.</i></td> <td></td> </tr> <tr> <td>9</td> <td>Dos posiciones extremas con anclajes. <i>Two ends positions with detent.</i></td> <td></td> </tr> <tr> <td>20</td> <td>Cuatro posiciones, tres normales y la cuarta anclada tirando corredera. <i>Four positions, three return by spring the fourth detented pulling spool.</i></td> <td></td> </tr> <tr> <td>37</td> <td>Accionamiento doble, dos correderas con una palanca. <i>Double action, two spools with one lever.</i></td> <td></td> </tr> <tr> <td>83</td> <td>Accionamiento por electroimán directo, tres posiciones centraje por muelle. <i>Direct solenoid operated, three positions spring centred.</i></td> <td></td> </tr> <tr> <td>84</td> <td>Accionamiento por electroimán directo, posición central y extrema. Electroimán lado toma A. <i>Direct solenoid operated, two positions (centre + one end). Solenoid side port A</i></td> <td></td> </tr> </table>	1	Tres posiciones recuperación por muelle. <i>Three positions, return to neutral by spring.</i>	5-175 bar	2	Tres posiciones con anclajes. <i>Three positions with detent.</i>		5	Microrruptor. <i>Microswitch.</i>		9	Dos posiciones extremas con anclajes. <i>Two ends positions with detent.</i>		20	Cuatro posiciones, tres normales y la cuarta anclada tirando corredera. <i>Four positions, three return by spring the fourth detented pulling spool.</i>		37	Accionamiento doble, dos correderas con una palanca. <i>Double action, two spools with one lever.</i>		83	Accionamiento por electroimán directo, tres posiciones centraje por muelle. <i>Direct solenoid operated, three positions spring centred.</i>		84	Accionamiento por electroimán directo, posición central y extrema. Electroimán lado toma A. <i>Direct solenoid operated, two positions (centre + one end). Solenoid side port A</i>					<table border="1" style="width: 100%; border-collapse: collapse;"> <tr> <th style="text-align: left;">Tipo de palanca mando Hand lever type</th> <td></td> </tr> <tr> <td>P2</td> <td>Palanca roscada doble con protección <i>Double threaded lever with bellows</i></td> </tr> <tr> <td>X</td> <td>Cuando lleve palancas diferentes ó múltiples <i>When different handles or joysticks are fitted</i></td> </tr> <tr> <td>I</td> <td>Accionamiento por cable <i>Cable operated</i></td> </tr> <tr> <td>S</td> <td>Sin palanca y tapa sin orejas <i>When no lever needed, a cover without ears will be assembled</i></td> </tr> </table>	Tipo de palanca mando Hand lever type		P2	Palanca roscada doble con protección <i>Double threaded lever with bellows</i>	X	Cuando lleve palancas diferentes ó múltiples <i>When different handles or joysticks are fitted</i>	I	Accionamiento por cable <i>Cable operated</i>	S	Sin palanca y tapa sin orejas <i>When no lever needed, a cover without ears will be assembled</i>
Tipo distribuidor Control valve type	302 - 1302																																																																					
Datos adicionales Additional data																																																																						
Gama de tensiones para C.C. (sólo para accionamiento 83-84) D.C. voltage (only for control types 83-84)	<table border="1" style="width: 100%; border-collapse: collapse;"> <tr> <td style="width: 25%;">12</td> <td style="width: 25%;">12 V</td> <td style="width: 25%;">24</td> <td style="width: 25%;">24 V</td> </tr> </table>	12	12 V	24	24 V																																																																	
12	12 V	24	24 V																																																																			
Sistemas de distribución Spool types	<p>Ver símbolos en paginas correspondientes. NOTA: El orden de las correderas se empieza a contar a partir de la válvula de seguridad.</p> <p><i>See symbols in relevant pages. NOTE: The spool order will be listed from the pressure to the exhaust port.</i></p>																																																																					
Taraje válvula seguridad Relief valve pressure range	<table border="1" style="width: 100%; border-collapse: collapse;"> <thead> <tr> <th style="text-align: left;">Tipo regulación / Adjustable</th> <th style="text-align: left;">Gama de taraje Pressure range bar</th> </tr> </thead> <tbody> <tr> <td>Regulable / Adjustable</td> <td></td> </tr> <tr> <td>11</td> <td>5 - 80</td> </tr> <tr> <td>12</td> <td>85 - 175</td> </tr> <tr> <td>13</td> <td>180 - 250</td> </tr> <tr> <td>14</td> <td>255 - 350</td> </tr> </tbody> </table> <p><small>Para distribuidores sin válvula de seguridad se omitirá el número de taraje. For valves without reliefs the pressure range number is omitted</small></p>	Tipo regulación / Adjustable	Gama de taraje Pressure range bar	Regulable / Adjustable		11	5 - 80	12	85 - 175	13	180 - 250	14	255 - 350																																																									
Tipo regulación / Adjustable	Gama de taraje Pressure range bar																																																																					
Regulable / Adjustable																																																																						
11	5 - 80																																																																					
12	85 - 175																																																																					
13	180 - 250																																																																					
14	255 - 350																																																																					
Posición vál. de seguridad o entrada presión Relief valve position / Pressure inlet																																																																						
Accionamiento corredera Spool positioning devices	<table border="1" style="width: 100%; border-collapse: collapse;"> <tr> <td style="width: 5%;">1</td> <td style="width: 85%;">Tres posiciones recuperación por muelle. <i>Three positions, return to neutral by spring.</i></td> <td style="width: 10%; text-align: right;">5-175 bar</td> </tr> <tr> <td>2</td> <td>Tres posiciones con anclajes. <i>Three positions with detent.</i></td> <td></td> </tr> <tr> <td>5</td> <td>Microrruptor. <i>Microswitch.</i></td> <td></td> </tr> <tr> <td>9</td> <td>Dos posiciones extremas con anclajes. <i>Two ends positions with detent.</i></td> <td></td> </tr> <tr> <td>20</td> <td>Cuatro posiciones, tres normales y la cuarta anclada tirando corredera. <i>Four positions, three return by spring the fourth detented pulling spool.</i></td> <td></td> </tr> <tr> <td>37</td> <td>Accionamiento doble, dos correderas con una palanca. <i>Double action, two spools with one lever.</i></td> <td></td> </tr> <tr> <td>83</td> <td>Accionamiento por electroimán directo, tres posiciones centraje por muelle. <i>Direct solenoid operated, three positions spring centred.</i></td> <td></td> </tr> <tr> <td>84</td> <td>Accionamiento por electroimán directo, posición central y extrema. Electroimán lado toma A. <i>Direct solenoid operated, two positions (centre + one end). Solenoid side port A</i></td> <td></td> </tr> </table>	1	Tres posiciones recuperación por muelle. <i>Three positions, return to neutral by spring.</i>	5-175 bar	2	Tres posiciones con anclajes. <i>Three positions with detent.</i>		5	Microrruptor. <i>Microswitch.</i>		9	Dos posiciones extremas con anclajes. <i>Two ends positions with detent.</i>		20	Cuatro posiciones, tres normales y la cuarta anclada tirando corredera. <i>Four positions, three return by spring the fourth detented pulling spool.</i>		37	Accionamiento doble, dos correderas con una palanca. <i>Double action, two spools with one lever.</i>		83	Accionamiento por electroimán directo, tres posiciones centraje por muelle. <i>Direct solenoid operated, three positions spring centred.</i>		84	Accionamiento por electroimán directo, posición central y extrema. Electroimán lado toma A. <i>Direct solenoid operated, two positions (centre + one end). Solenoid side port A</i>																																														
1	Tres posiciones recuperación por muelle. <i>Three positions, return to neutral by spring.</i>	5-175 bar																																																																				
2	Tres posiciones con anclajes. <i>Three positions with detent.</i>																																																																					
5	Microrruptor. <i>Microswitch.</i>																																																																					
9	Dos posiciones extremas con anclajes. <i>Two ends positions with detent.</i>																																																																					
20	Cuatro posiciones, tres normales y la cuarta anclada tirando corredera. <i>Four positions, three return by spring the fourth detented pulling spool.</i>																																																																					
37	Accionamiento doble, dos correderas con una palanca. <i>Double action, two spools with one lever.</i>																																																																					
83	Accionamiento por electroimán directo, tres posiciones centraje por muelle. <i>Direct solenoid operated, three positions spring centred.</i>																																																																					
84	Accionamiento por electroimán directo, posición central y extrema. Electroimán lado toma A. <i>Direct solenoid operated, two positions (centre + one end). Solenoid side port A</i>																																																																					
		<table border="1" style="width: 100%; border-collapse: collapse;"> <tr> <th style="text-align: left;">Tipo de palanca mando Hand lever type</th> <td></td> </tr> <tr> <td>P2</td> <td>Palanca roscada doble con protección <i>Double threaded lever with bellows</i></td> </tr> <tr> <td>X</td> <td>Cuando lleve palancas diferentes ó múltiples <i>When different handles or joysticks are fitted</i></td> </tr> <tr> <td>I</td> <td>Accionamiento por cable <i>Cable operated</i></td> </tr> <tr> <td>S</td> <td>Sin palanca y tapa sin orejas <i>When no lever needed, a cover without ears will be assembled</i></td> </tr> </table>	Tipo de palanca mando Hand lever type		P2	Palanca roscada doble con protección <i>Double threaded lever with bellows</i>	X	Cuando lleve palancas diferentes ó múltiples <i>When different handles or joysticks are fitted</i>	I	Accionamiento por cable <i>Cable operated</i>	S	Sin palanca y tapa sin orejas <i>When no lever needed, a cover without ears will be assembled</i>																																																										
Tipo de palanca mando Hand lever type																																																																						
P2	Palanca roscada doble con protección <i>Double threaded lever with bellows</i>																																																																					
X	Cuando lleve palancas diferentes ó múltiples <i>When different handles or joysticks are fitted</i>																																																																					
I	Accionamiento por cable <i>Cable operated</i>																																																																					
S	Sin palanca y tapa sin orejas <i>When no lever needed, a cover without ears will be assembled</i>																																																																					

Datos técnicos
Technical data

Datos técnicos / Technical data	
Presión máxima <i>Maximum pressure</i>	350 bar
Caudal nominal <i>Nominal flow rate</i>	40 L/min.
Potencia electroimán <i>Solenoid power</i>	40 W
Gama de tensiones <i>Control voltage</i>	D.C. 12-24 V. nom. ± 10%
Fluido recomendado <i>Fluid to be used</i>	ISO 6743 Tipo HM, HV o HG
Gama de temperaturas del fluido <i>Fluid temperature range</i>	-20°C +80°C
Gama de viscosidades <i>Viscosity range</i>	ISO 3448 CAT. VG32-VG46
Grado de limpieza del aceite <i>Recommended fluid cleanliness</i>	16/13 s./ ISO 4406 or RP70H or 10 s./ NAS 1638
Alimentación tipo <i>Type</i>	Paralelo / <i>Parallel</i>

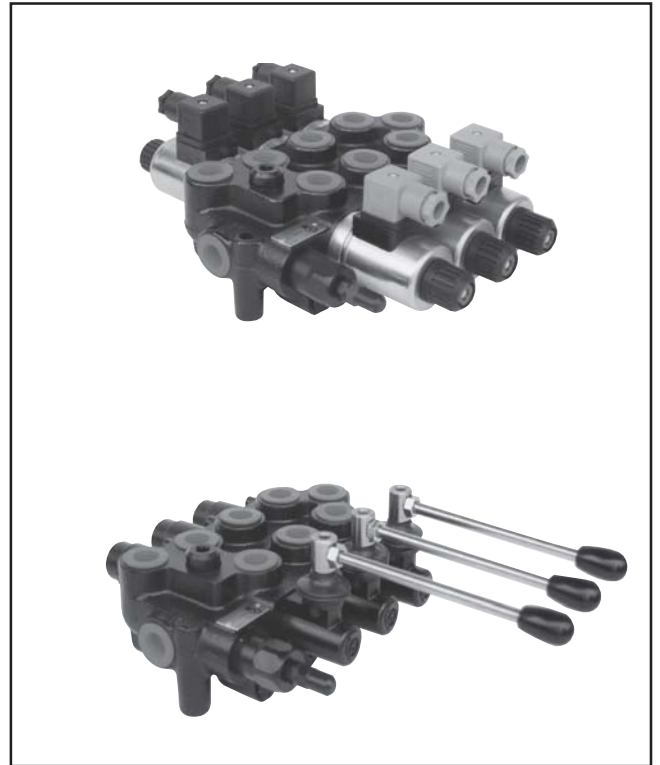

Diagramas:
Diagrams:

Δp -Q a 27 cSt.

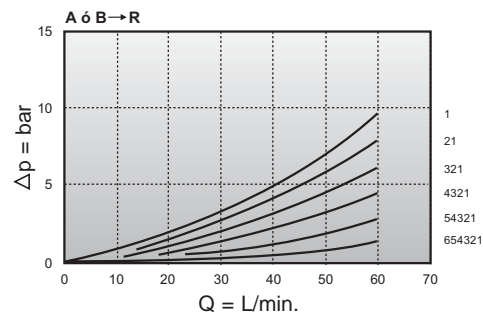
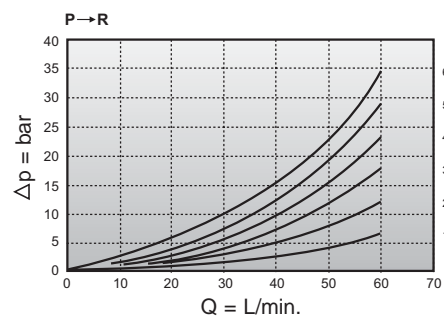
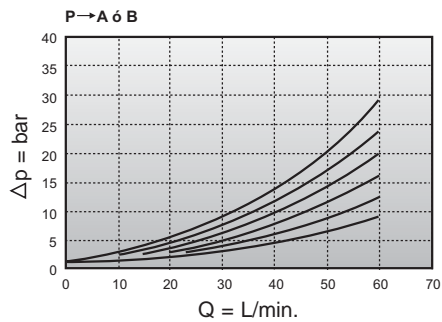

Limites de funcionamiento
Operating limits

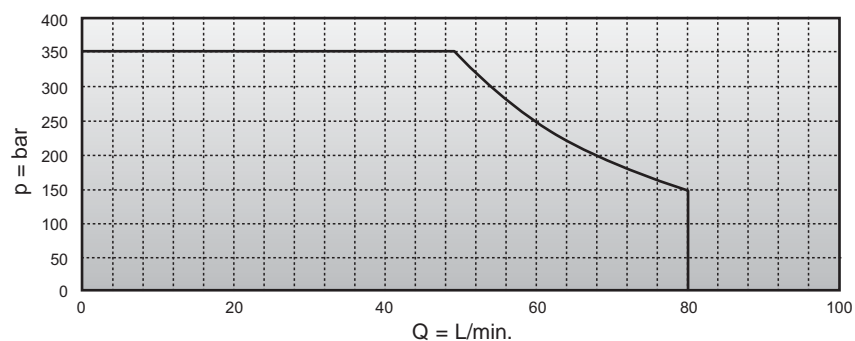

Sistemas de distribución
Spool types

Sólo mando manual
Only manual control

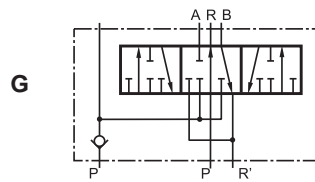
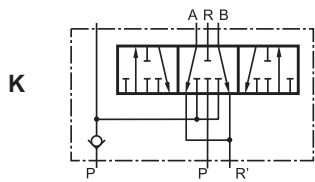
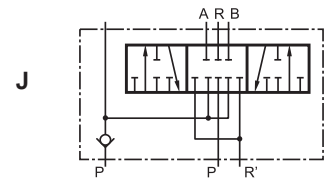
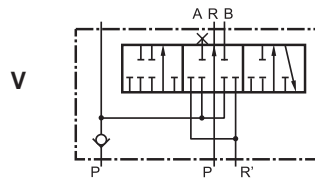
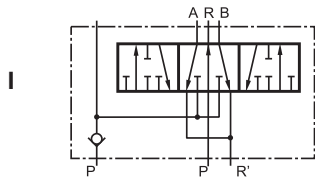
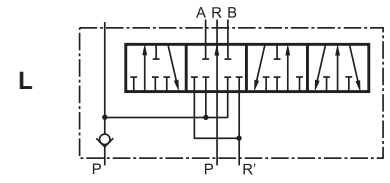
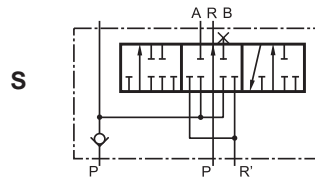
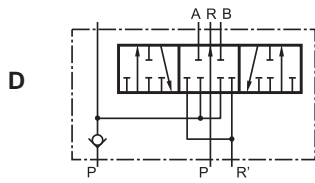

Esquema de funcionamiento
Functional schematic

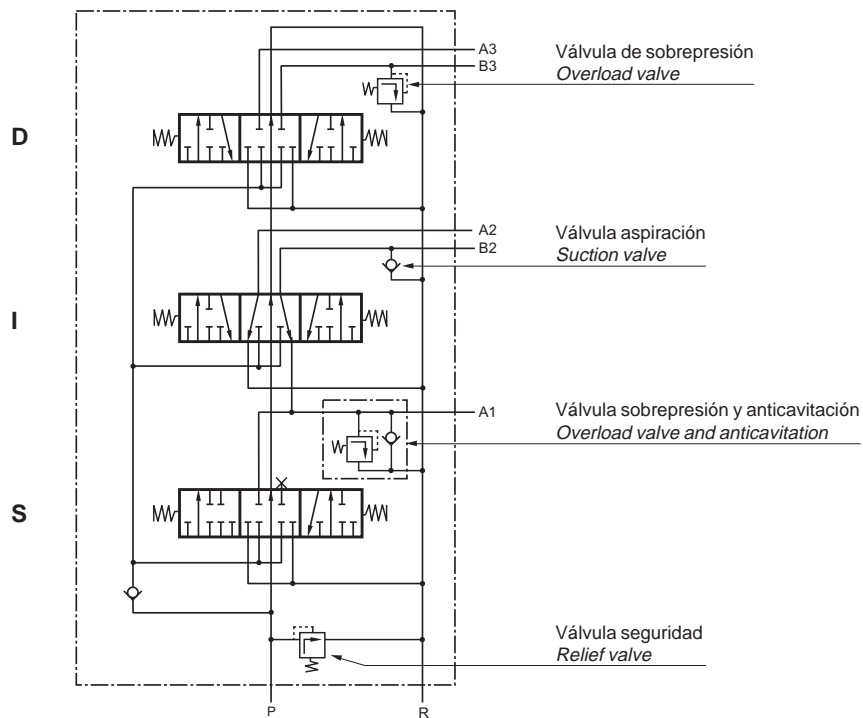

Medidas distribuidor eléctrico
Electric control valve measurements

Forma retorno Return type	Tomas / Ports G (B.S.P.)			
	P - P1	R	R1	A - B
N Paso libre Open centre	1/2"	1/2"	1/2"	Tipo Type 302 3/8"
C Centro cerrado Closed centre		Tapón Plug		
Z Retorno con presión High pressure carry-over		3/8"		Tipo Type 1302 1/2"

Nº de elementos Number of spools	1	2	3	4	5	6
C	114	160	206	252	298	344
D	89	135	181	227	273	319
Peso (Kg.) - Weight	5,9	8,2	10,6	12,9	15,4	17,8

P-P1 = Entrada a presión indistintivamente.
Both are pressure ports.

A-B = Tomas a cilindros o motores.
Outlet ports.

R-R1 = Retorno a depósito en distribuidores normales.
Both are exhaust ports.

**EN DISTRIBUIDORES CON RETORNO A PRESIÓN.
CONTROL VALVES WITH HIGH PRESSURE CARRY OVER.**

R = Salida utilizable con presión.
High pressure carry over.

R1 = Retorno a depósito.
Exhaust port.

**EN DISTRIBUIDORES DE CENTRO CERRADO.
CONTROL VALVES WITH CLOSED CENTRE.**

R = Estará cerrado.
Closed.

R1 = Retorno a depósito.
Exhaust port.

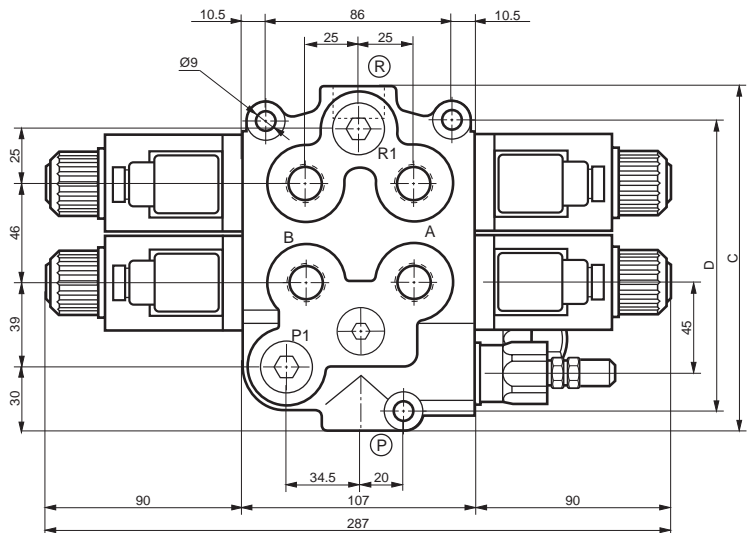
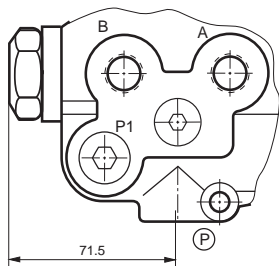
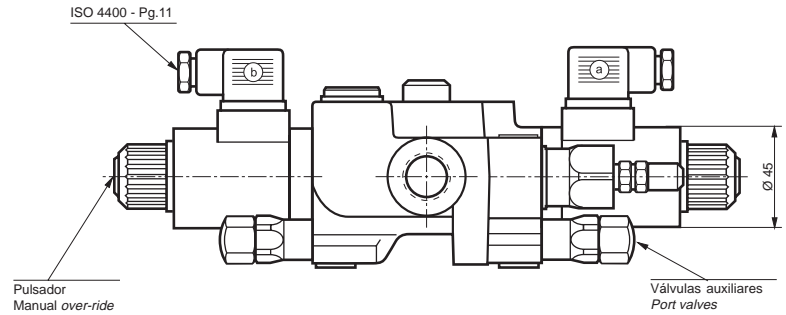
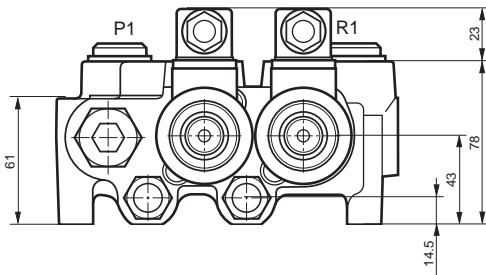

Accionamiento 84
Single solenoid port A

Accionamiento 83
Twin solenoid

Medida distribuidor mando manual
Manual control valve measurements

Forma retorno Return type	Tomas / Ports G (B.S.P.)			
	P - P1	R	R1	A - B
N Paso libre Open centre	1/2"	1/2"	1/2"	Tipo Type 302 3/8"
C Centro cerrado Closed centre		Tapón Plug		Tipo Type 1302 1/2"
Z Retorno con presión High pressure carry-over		3/8"		

Nº de elementos Number of spools	1	2	3	4	5	6
C	114	160	206	252	298	344
D	89	135	181	227	273	319
Peso (Kg.) - Weight	5,3	7,6	9,9	12,2	14,5	16,8

Accionamiento manual Tipo P2 / Hand operated Type P2		
0 Posición central Neutral	1 Corredera salida Spool out	2 Corredera entrada Spool in

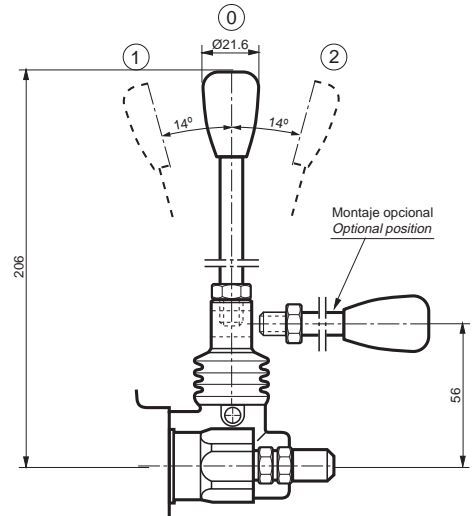

Puede ir montado en cualquier elemento
 Can be fitted to any element in a block

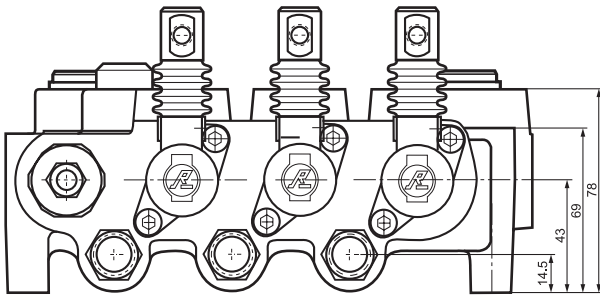

DETALLE CABEZA CORREDERA
SPOOL HEAD DETAIL

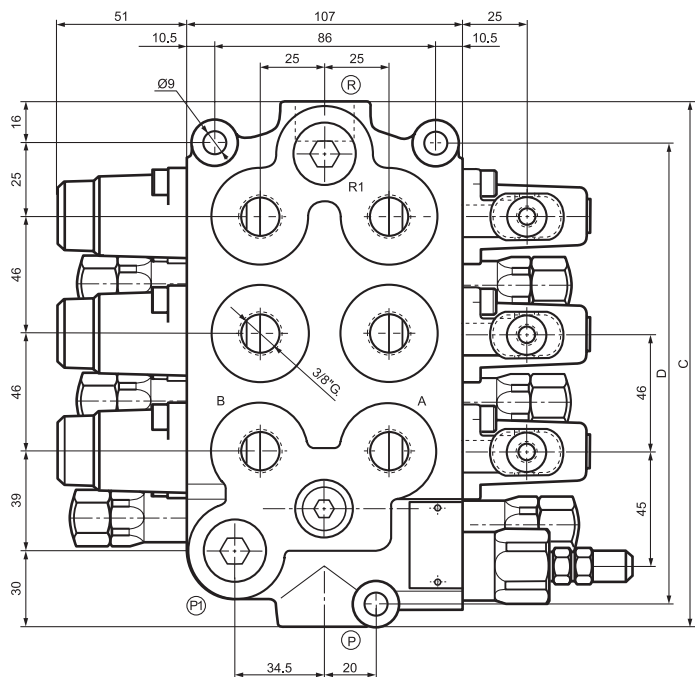
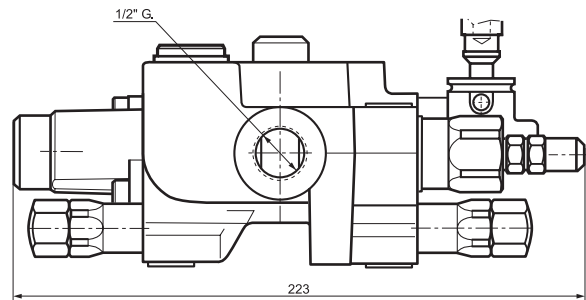
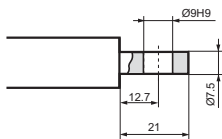
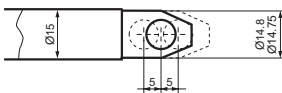

P-P1 = Entrada a presión indistintivamente.
 Both are pressure ports.

A-B = Tomas a cilindros o motores.
 Outlet ports.

R-R1 = Retorno a depósito en distribuidores normales.
 Both are exhaust ports.

EN DISTRIBUIDORES CON RETORNO A PRESIÓN.
CONTROL VALVES WITH HIGH PRESSURE CARRY OVER.

R = Salida utilizable con presión.
 High pressure carry over.

R1 = Retorno a depósito.
 Exhaust port.

EN DISTRIBUIDORES DE CENTRO CERRADO.
CONTROL VALVES WITH CLOSED CENTRE.

R = Estará cerrado.
 Closed.

R1 = Retorno a depósito.
 Exhaust port.

Variantes de accionamiento corredera
Spool operation types

Accionamiento 1
Type 1

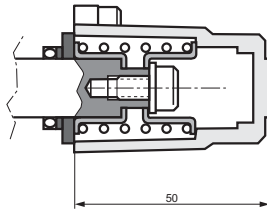

Accionamiento 2
Type 2

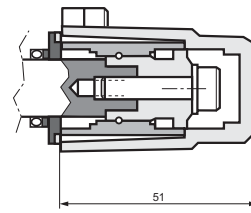

Accionamiento 9
Type 9

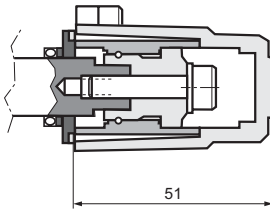

Accionamiento 20
Type 20

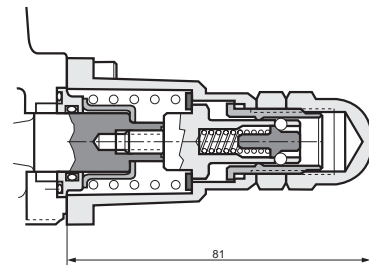

Accionamiento 5
Type 5

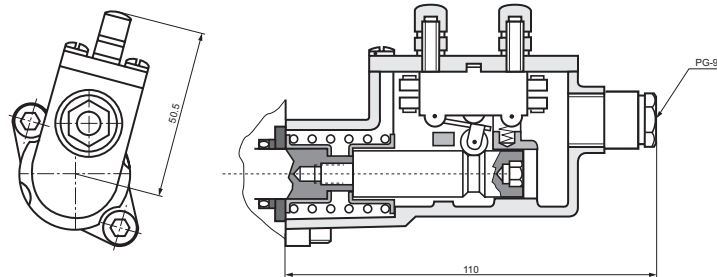

Variantes de accionamiento de palanca
Lever operation types

Accionamiento por palanca múltiple
Multiple lever operated

Tipo +
Type +

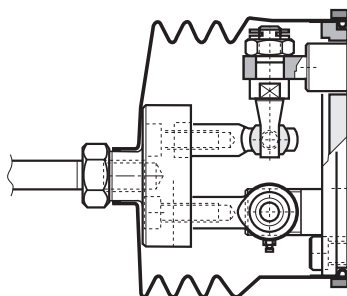

Accionamiento por cable
Cable operated

Tipo I
Type I

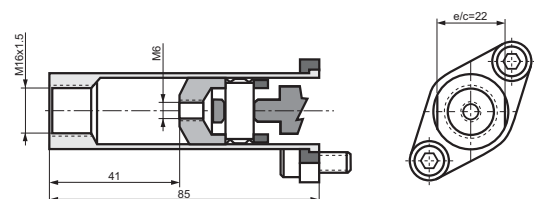

Distribuidor paralelo
Parallel control valves

Accionamiento manual / Hand operated

** 11 - 12 - 13 - 14

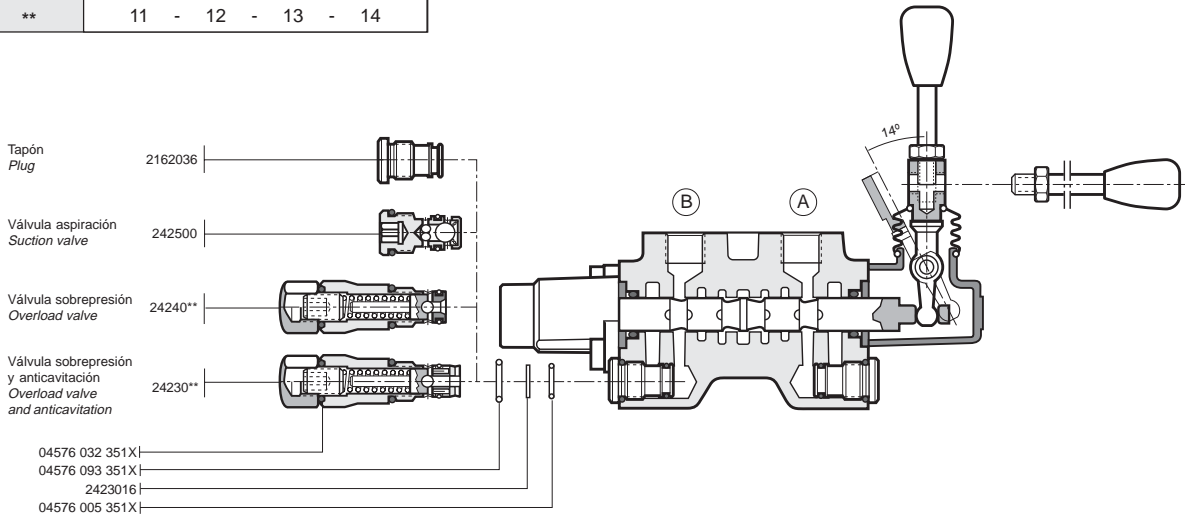

Accionamiento eléctrico / Solenoid operated

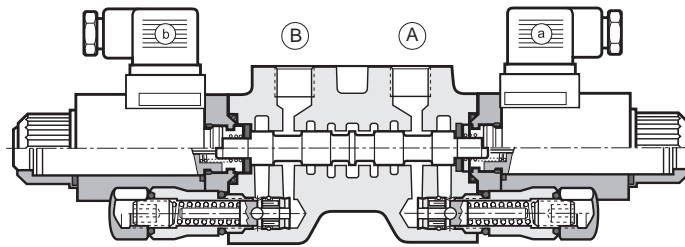

Piezas para retorno con presión
Parts for high pressure carry over

Piezas para centro cerrado
Parts for closed centre

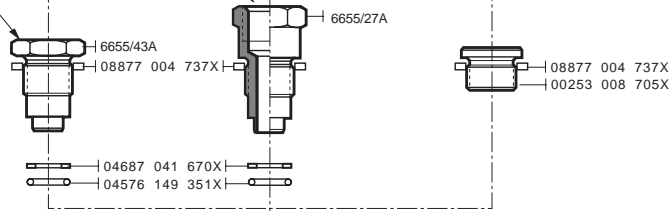

Válvula paralelo
Parallel valve

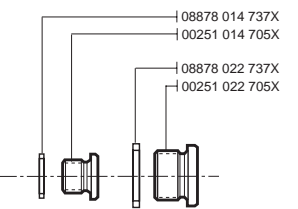
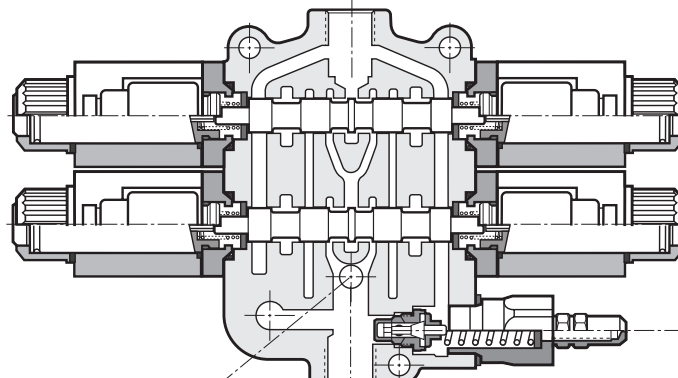
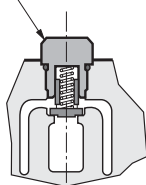

Piezas para suprimir válvula seguridad
Parts needed when no relief valve

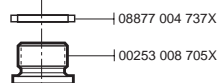

Diagramas:
Diagrams:

Δp -Q a 27 cSt.

Válvula seguridad
Relief valve

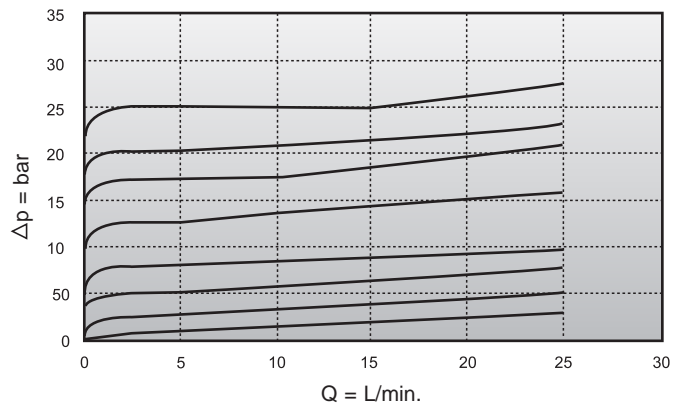

Válvula sobrepresión
Overload valve

24240**

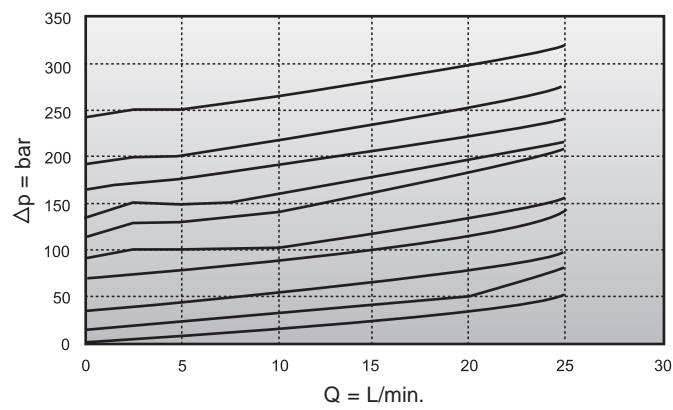

Válvula sobrepresión y aspiración
Overload valve and anticavitation

24230**

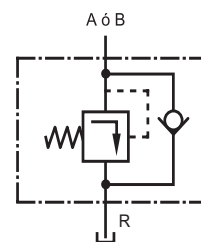
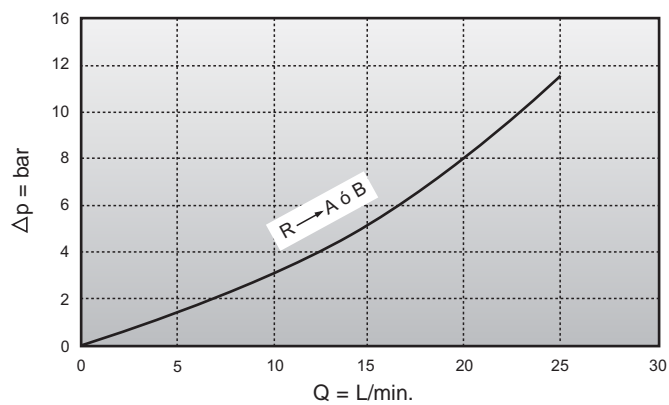

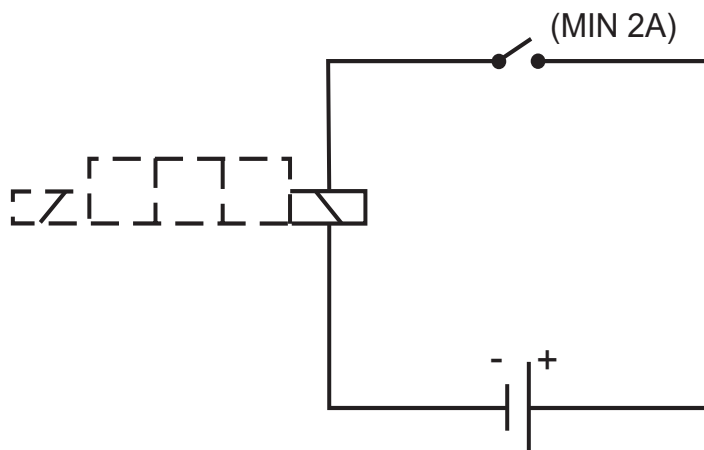

Prensaestopas PGH11 (Cable Ø 8-10mm)

Cable gland PG11 (Cable Ø 8-10mm)

Evitar usar el chasis como conductor.

Avoid using chassis as a conductor.

Tener en cuenta las pérdidas de carga desde la fuente de alimentación hasta el electroimán. Se admite como máximo una pérdida de 2V. Para calcular la sección y la longitud adecuada puede usarse la siguiente expresión:

Consider the losses between the power supply and the solenoid. Losses should not exceed 2V. To calculate the section necessary for a specific length and voltage drop, use the following formula:

$$A = \frac{2 \cdot L \cdot I}{57 \cdot u}$$

$$A = \frac{2 \cdot L \cdot I}{57 \cdot u}$$

donde:

where:

- A** es la sección en mm² del conductor.
- L** es la longitud en m del conductor.
- I** es la intensidad en A que debe circular.
- 57** es la conductividad del material conductor (cobre).
- u** es la caída de tensión en V.

- A** is the cable cross-section in mm².
- L** is the cable length.
- I** is the required current.
- 57** is the conductivity of the material (copper).
- u** is the voltage drop.

Para los electroimanes montados, se aconsejan las siguiente longitudes y secciones:

For fitted solenoids it is advisable to use the following lengths and cross-sections:

Sección de conductor en mm ² Cable cross-section (mm ²)	Longitud max. para una c.d.t Max. length for a voltage drop of 2V (m)
1.5	45.75
2.5	71.25
4	114

PEDRO ROQUET, S.A. se reserva el derecho de efectuar cualquier modificación en las características señaladas en este catálogo, sin previo aviso, y sin incurrir en responsabilidad alguna.

*PEDRO ROQUET, S.A. keeps the right to modify any characteristic in this catalogue without informing.
No responsibility is accepted for it.*

Pedro Roquet, s/a

Antonio Figueras,91 - 08551 TONA (Barcelona) SPAIN

Nac. Tel. 93 812 46 64 - Fax 93 887 17 98

Int. Tel. +34 93 812 46 64 - Fax +34 93 887 17 98

www.pedro-roquet.com